

373 COLLECTION

TISSUE HOLDER WITH SHELF

373159

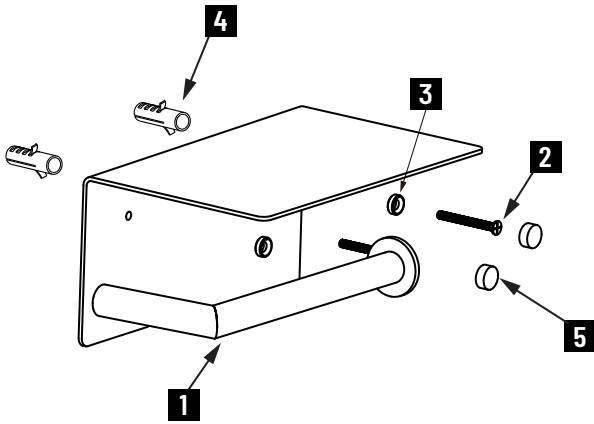

- 1. Tissue Holder with shelf x 1
- 2. Wall Screw x 2
- 3. Bracket x 2
- 4. Plug x 2
- 5. End Cap x 2

Tools required for installation

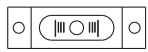

Level

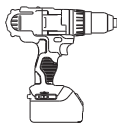

Drill



Pencil



Screwdriver



Hammer

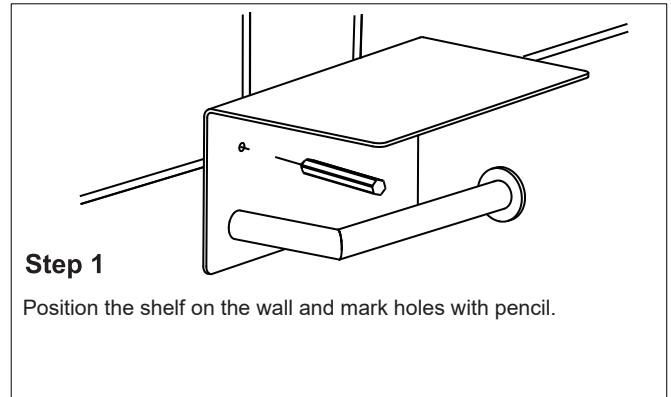

Step 1

Position the shelf on the wall and mark holes with pencil.

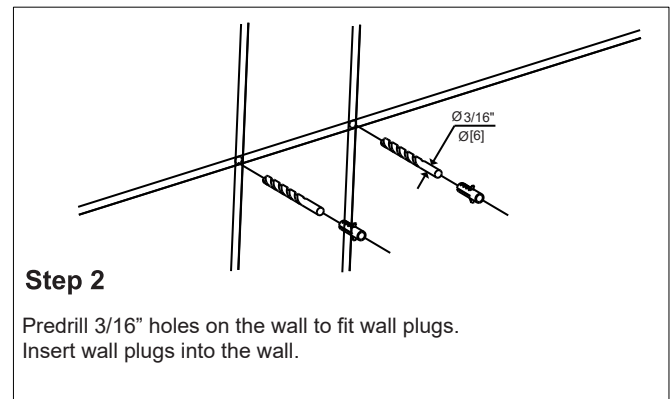

Step 2

Predrill 3/16" holes on the wall to fit wall plugs. Insert wall plugs into the wall.

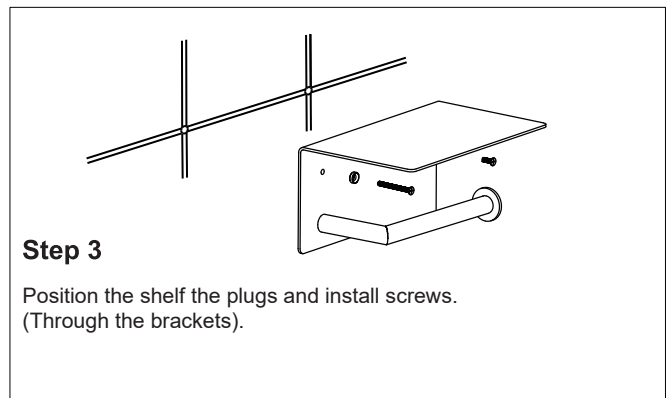

Step 3

Position the shelf the plugs and install screws. (Through the brackets).

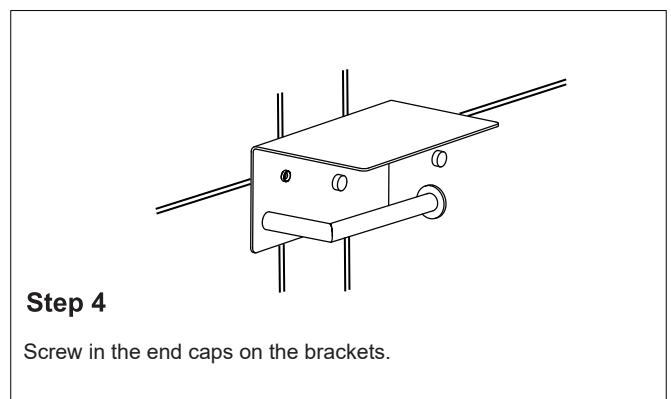

Step 4

Screw in the end caps on the brackets.