

## 353 COLLECTION

### TISSUE HOLDER WITH SHELF

353159

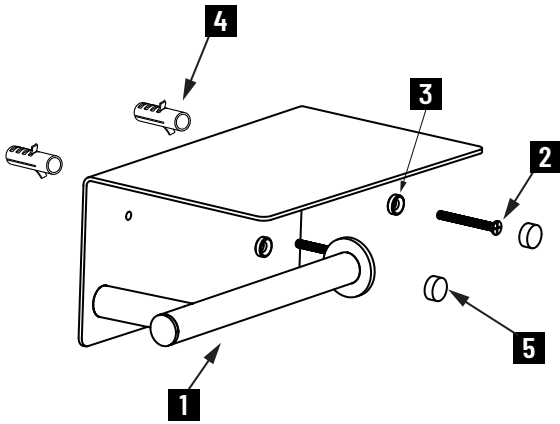

- 1. Tissue Holder with shelf x 1
- 2. Wall Screw x 2
- 3. Bracket x 2
- 4. Plug x 2
- 5. End Cap x 2

#### Tools required for installation

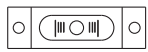

Level

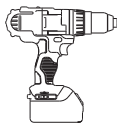

Drill



Pencil



Screwdriver



Hammer

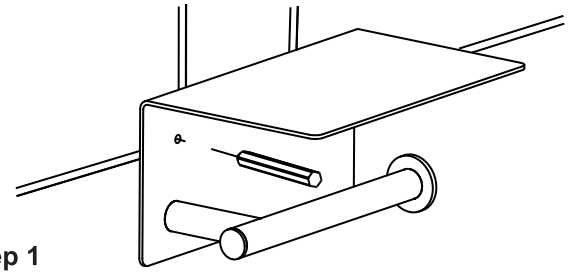

#### Step 1

Position the shelf on the wall and mark holes with pencil.

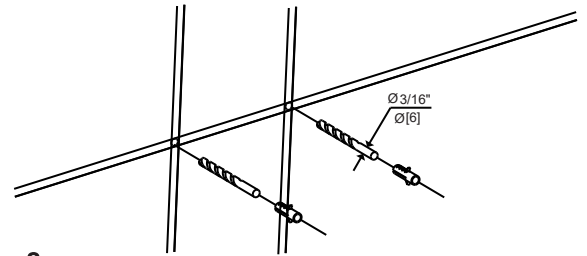

#### Step 2

Pre-drill 3/16" holes on the wall to fit wall plugs. Insert wall plugs into the wall.

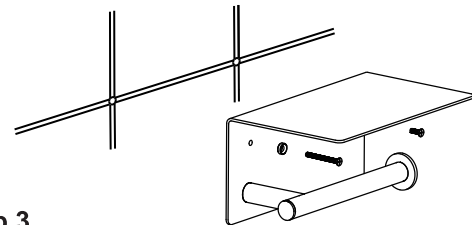

#### Step 3

Position the shelf the plugs and install screws. (Through the brackets).

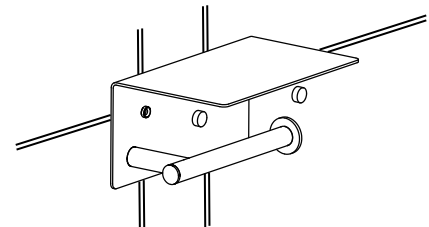

#### Step 4

Screw in the end caps on the brackets.