

## LONDON COLLECTION

### TISSUE HOLDER

248158

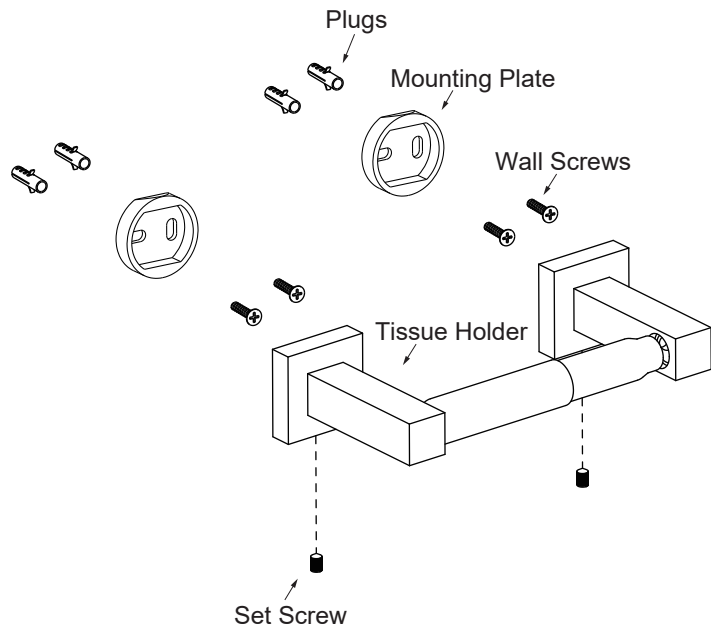

#### Tools required for installation



Level

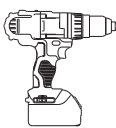

Drill



Pencil

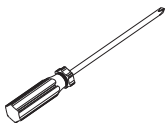

Screwdriver



Hammer

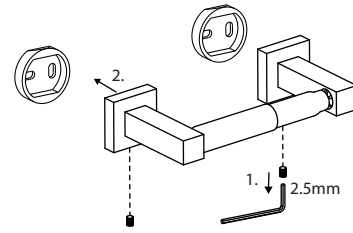

#### Step 1

Loosen the set screw on the accessory and remove the backing plates. Position the accessory against the wall and mark outline with pencil.

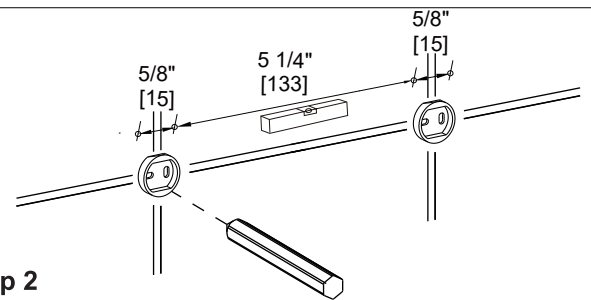

#### Step 2

Position the backing plates flat side down on the wall and mark holes with pencil.

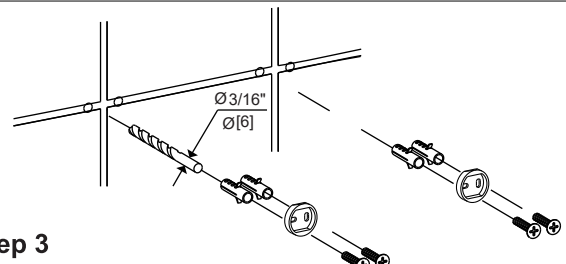

#### Step 3

Predrill 3/16" holes on the wall to fit wall plugs. Insert wall plugs into the wall. Position backing plates flat side down over the plugs and install screws.

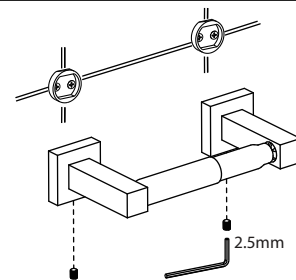

#### Step 4

Slide the accessory onto the backing plates and tighten the set screws using Allen key provided.